

IMPORTANT: RECEIVING INSTRUCTIONS

Visually inspect all components for shipping damage. If you find damage, notify the carrier at once.

Shipping damage is NOT covered by warranty. The carrier is responsible for all repair or replacement costs resulting from damage in shipment.

Due to continuing improvements, actual product may differ slightly from the product described herein.

Tools required for assembly and service may not be included.

Read this material before using this product. Failure to do so can result in serious injury. SAVE THIS MANUAL.



CONTENTS

1.0 Warnings and Safety

1.1 Pipe Threader Safety Warnings

1.2 Vibration Safety

2.0 Extension Cords

3.0 Symbols

4.0 Specifications

5.0 Functions

6.0 Operation

6.1 Threader Set Up

6.2 Work Area Set Up

6.3 Operating Instructions

7.0 Maintenance

7.1 Replacing Brushes in Motor

7.2 Replacing the Die Blades

7.3 Troubleshooting

8.0 Warranty Information

1.0 WARNINGS AND SAFETY

WARNING

READ ALL SAFETY WARNINGS AND ALL INSTRUCTIONS.

Failure to follow the warnings and instructions may result in electric shock, fire and/or serious injury.

- Do not operate the tool on damp or wet surfaces. Do not stand on wet surfaces while operating the tool.
- Read and understand all instructions and warning information in this manual before operating this machine.
- Do not use this machine in a hazardous environment. Hazards include flammable liquids, gases, or other materials. Using this tool in hazardous environments can result in a fire or explosion.
- Electric shock hazard. Inspect power cord before use. Repair or replace if it is damaged. DO not modify the power cord or plug.
- Always use safety glasses. Everyday glasses are NOT safety glasses. When using in dusty environment, use face or dust mask.
- Do not use damaged extension cords. Use only three-wire, 12 AWG extension cords that have three-prong grounding-type plugs and three-hole receptacles that accept the tool's plug.
- Reduce the risk of unintentional starting by making sure switch is in off position before plugging in. Never leave machine unattended. Turn power off and do not leave machine until it comes to a complete stop.
- Keep working area clear from any tools or other equipment when using the threader.
- Unplug tool from any power source before disassembling, reassembling, and repairing any parts.
- Wear proper apparel. Do not wear loose clothing, gloves, neckties, rings, bracelets, or other jewelry which may get caught in moving parts. Nonslip footwear is recommended. Wear protective hair covering to contain long hair.
- Keep children away. All visitors should be kept safe distance from work area.
- Make workshop kid proof with padlocks, master switches, or by removing starter keys.
- Use recommended accessories. The use of improper accessories may cause risk of injury to person
- Maintain tool with care. Keep tool clean for best and safest performance. Follow maintenance and troubleshooting instructions for changing parts.
- Keep all decals on bender clean and legible at all times.
- Inspect for any damaged/malfunctioning parts before use.
If any damaged/malfunctioning parts are found during inspection, repair or replace parts.
- Do not use the tool if the Trigger does not turn it on and off.

1.1 Pipe Threader Safety Warnings

1. Secure the pipe being threaded with the Clamp before use.
2. Make sure work area is prepared and ready for use before turning on the threader.
3. Do not lay the tool down until it has come to a complete stop to avoid the threader catching surface and being pulled out of your control.
4. Maintain a firm grip on the tool with both hands to resist starting torque.
5. Turn off the tool and unplug it from its electrical outlet before leaving the work space.
6. People with pacemakers should consult their physician(s) before use. Electromagnetic fields in close proximity to heart pacemaker could cause pacemaker interference or pacemaker failure. In addition, people with pacemakers should:
 - Avoid operating alone.
 - Do not use with Trigger locked on.
 - Properly maintain and inspect to avoid electrical shock.
 - Properly ground power cord. Ground Fault Circuit Interrupter (GFCI) should also be implemented – it prevents sustained electrical shock.
7.  **WARNING:** Cancer and Reproductive Harm - www.P65Warnings.ca.gov.
8. The warnings, precautions, and instructions discussed in this instruction manual cannot cover all possible conditions and situations that may occur. It must be understood by the operator that common sense and caution are factors which cannot be built into this product, but must be supplied by the operator.

1.2 Vibration Safety

This tool vibrates during use. Repeated or long-term exposure to vibration may cause temporary or permanent physical injury, particularly to the hands, arms and shoulders. To reduce the risk of vibration-related injury:

1. Anyone using vibrating tools regularly or for an extended period should first be examined by a doctor and then have regular medical check-ups to ensure medical problems are not being caused or worsened from use. Pregnant women or people who have impaired blood circulation to the hand, past hand injuries, nervous system disorders, diabetes, or Raynaud's Disease should not use this tool. If you feel any symptoms related to vibration (such as tingling, numbness, and white or blue fingers), seek medical advice as soon as possible.
2. Do not smoke during use. Nicotine reduces the blood supply to the hands and fingers, increasing the risk of vibration-related injury.
3. Wear suitable gloves to reduce the vibration effects on the user.
4. Use tools with the lowest vibration when there is a choice.
5. Include vibration-free periods each day of work.
6. Grip tool as lightly as possible (while still keeping safe control of it). Let the tool do the work.
7. To reduce vibration, maintain the tool as explained in this manual. If any abnormal vibration occurs, stop use immediately.

SAVE THESE INSTRUCTIONS.

2.0 EXTENSION CORDS

- GROUNDING** tools require a three wire extension cord. **DOUBLE INSULATED** tools can use either a two or three wire extension cord.
- As the distance from the supply outlet increases, you must use a heavier gauge extension cord. Using extension cords with inadequately sized wire causes a serious drop in voltage, resulting in loss of power and possible tool damage. (See Table A.)
- When using more than one extension cord to make up the total length, make sure each cord contains at least the minimum wire size required. (See Table A.)
- If you are using one extension cord for more than one tool, a larger minimum cord size will be required.
- If you are using an extension cord outdoors, make sure it is marked with the suffix "W-A" ("W" in Canada) to indicate it is acceptable for outdoor use.
- Always replace a damaged extension cord or have it repaired by a qualified electrician before using it.
- Protect the extension cords from sharp objects, excessive heat, and damp or wet areas.









TABLE A: RECOMMENDED MINIMUM WIRE GAUGE FOR EXTENSION CORDS* (120/240 VOLT)

NAMEPLATE AMPERES (AT FULL LOAD)	EXTENSION CORD LENGTH				
	25'	50'	75'	100'	150'
11.0	18	14	12	10	-

* Based on limiting the line voltage drop to five volts at 150% of the rated amperes.

3.0 SYMBOLS

V	VOLTS
~	ALTERNATING CURRENT
A	AMPERES

n0 xxxx/min.	No Load Revolutions per Minute (RPM)
	Safety alert symbol. Obey all safety messages that follow this symbol to avoid possible injury or death.
	Read the manual before set-up and/or use.
	WARNING marking concerning Risk of Eye Injury. Wear ANSI-approved safety goggles with side shields.
	Do not wear gloves while operating this machine to reduce the risk of entanglement.
	Risk of fingers, hands, clothes and other objects catching on or between gears or other rotating parts and causing crushing injuries.
	Use support device to resist the threading forces, improve control, and reduce the risk of striking, crushing, and/or other injuries.
	WARNING marking concerning Risk of Fire. Do not cover ventilation ducts. Keep flammable objects away.
	WARNING marking concerning Risk of Electric Shock. Properly connect power cord to appropriate outlet.

4.0 SPECIFICATIONS

Electrical Rating	120VAC / 60Hz / 11A
Die Size	1/2", 3/4", 1", 1-1/4" (11-R Dies) 1-1/2", 2" (Large Octagonal-Style Dies)
Watts	1228W
N₀	28/min
Duty	S3, 40 sec., 40%
Motor Type	Universal Motor, Single Phase

Controls	Forward/Reverse Switch, ON/OFF Momentary Contact Switch, Locking Switch
Gear Head	Die Cast Aluminum
Length	24.5 (622.3mm)
Width	5 in. (127mm)
Height	8 in. (203.2mm)
Weight	18 lbs.



Read the **ENTIRE IMPORTANT SAFETY INFORMATION** section at the beginning of this manual including all text under subheadings therein before set up or use of this product.

5.0 FUNCTIONS

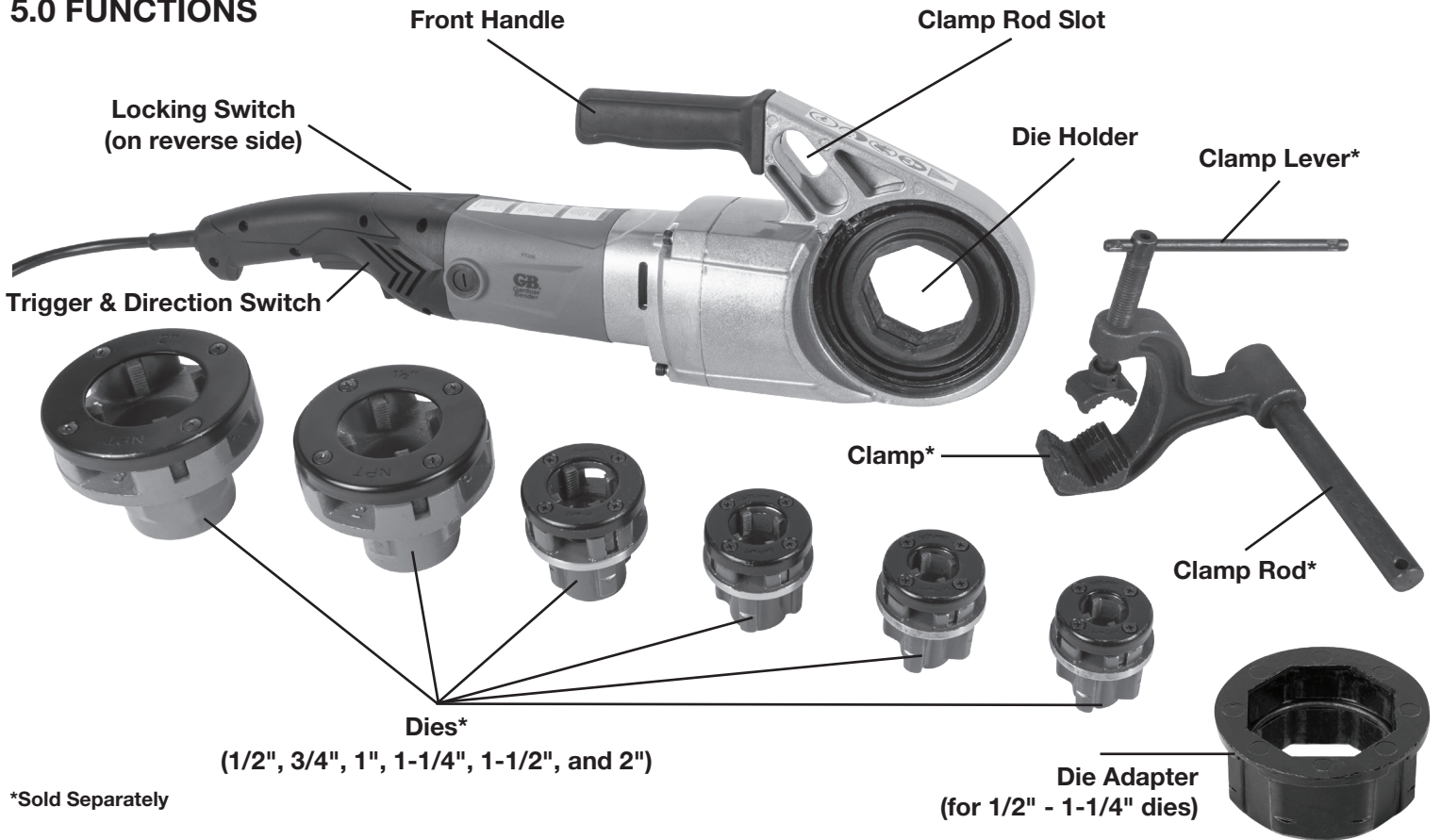

*Sold Separately

6.0 OPERATION

6.1 Threader Set Up

WARNING

TO PREVENT SERIOUS INJURY FROM ACCIDENTAL OPERATION:

Make sure that the trigger is in the off-position and unplug the tool from its electrical outlet before performing any procedure in this section.

1. Select the appropriate die size for the pipe to be threaded.
Note: Dies are intended for use on standard schedule 40 steel pipe.
2. Insert Die into the Die Holder of the Pipe Threader. (See Figure A.) Make sure the Die is secured in place before proceeding.
Note: Dies must be inserted into the right side of the Pipe Threader.
Note: Die may require slight force to be properly inserted and held into the threader.
3. Keep a filled oil can with thread cutting oil nearby during the threading operation.



Figure A

6.2 Work Area Set Up

1. Keep work area clean and well lit. Do not allow children or pets into the work area to prevent distraction and injury.
2. Route power cord along a safe route to reach the work area without creating a tripping hazard or exposing the power cord to possible damage. Power cord must reach the work area with enough extra length to allow free movement while working.
3. There must not be objects, such as utility lines, nearby that will present a hazard while working.
4. Use Clamp assembly to secure and support pipe during threading operation. Screw Clamp Rod into Clamp. Make sure pipe is secured to Clamp assembly and is supported during threading operation.
5. Install Clamp Rod into Clamp Rod Slot.
6. Insert pipe into toothless end of Die. Make sure inside diameter of Die matches outside diameter of pipe. (See Figure B.)

Note: Pipe end to be threaded must be clean and chamfered.

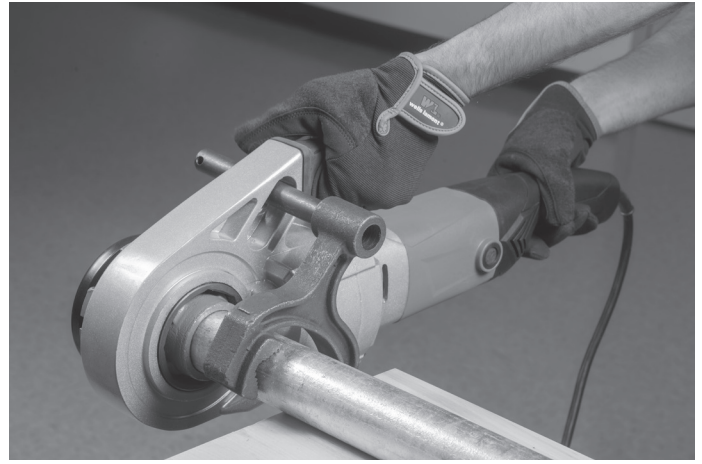

Figure B

6.3 Operating Instructions

1. Make sure pipe end and threads of Die are sufficiently oiled at all times to extend the life of the Die Blades and ensure that the threads are not rough.
2. The Direction Switch determines the direction of the threading operation. Flip Rotating Direction Switch to right position for a clockwise rotation. Flip Rotating Direction Switch to left position for a counter-clockwise rotation.
3. Make sure Trigger is in the off-position before plugging in the tool.
4. While holding Handle, press Trigger in to turn the threader.
5. If the Die does not engage the pipe, apply slight pressure on the end of the Die until it engages pipe.
6. The Die will automatically be drawn over the pipe and a standard taper thread will be cut.
7. To ensure a good, clean standard taper thread, stop Pipe Threader every few turns, reverse, oil pipe, and re-cut thread.
8. Stop threading when the end of the Die is flush with the end of the pipe. At this point, the correct thread length has been reached to produce the proper joint. To continue beyond this point would make a straight or running thread.
9. To finish threading operation:
 - a. Release Trigger. Allow Pipe Threader to completely stop.
 - b. Reverse Direction Switch.
 - c. Squeeze Trigger to turn on Pipe Threader. Allow Die to reverse path of thread until it has fully expelled pipe.
 - d. Release Trigger. Avoid damaging newly cut threads when removing pipe from Pipe Threader.

⚠ CAUTION! Freshly cut threads may be hot and have sharp edges or sharp metal turnings still attached. Clean pipe and allow it to cool before use.

10. **IMPORTANT:** Clean any oil spills on the ground. At the end of each job, clean Pipe Threader and store in a clean, dry, safe location out of reach of children and unauthorized people.
11. To prevent accidents, turn off tool and unplug it after use. Clean, then store tool indoors out of children's reach.
12. To lock the threader rotation, push down on the Locking Switch while the trigger is being squeezed. This will allow the threader to continuously rotate without having to hold the trigger. Squeeze the trigger again to release the locking mechanism.

7.0 MAINTENANCE

 Procedures not specifically explained in this manual must be performed only by a qualified technician.

WARNING

TO PREVENT SERIOUS INJURY FROM ACCIDENTAL OPERATION:

Make sure that the Trigger is in the off-position and unplug the tool from its electrical outlet before performing any procedure in this section.

TO PREVENT SERIOUS INJURY FROM ACCIDENTAL OPERATION:

Do not use damaged equipment. If abnormal noise or vibration occurs, have the problem corrected before further use.

- BEFORE EACH USE**, inspect the general condition of the tool.
Check for:
 - loose hardware.
 - misalignment or binding of moving parts
 - damaged cord/electrical wiring.
 - cracked or broken parts, and any other condition that may affect safe operation
- AFTER USE**, wipe external surfaces of the tool with clean cloth.
- ⚠WARNING!** If the supply cord of this power tool is damaged, it must be replaced only by a qualified service technician.

7.1 Replacing Brushes in Motor

Check motor brushes every 6 months. Replace when worn to less than 5/16" (8 mm)

- Unplug the machine from power source.
- Unscrew brush caps. Remove and inspect brushes. Inspect the commutator for wear. If excessively worn, have tool serviced.
- Re-install brushes/install new brushes and securely tighten the brush caps.
- It is best practice to run the unit at idle for 15 minutes in the forward direction followed by 15 minutes in the reverse direction to seat the brushes to the commutator before use.



Figure C

7.2 Replacing the Die Blades

- Worn Die Blades can result in poor thread quality. When replacing Die Blades, verify that the size of the new Die Blades corresponds to the size of the Die.

To replace the Die Blades:

- Remove the four Screws on the Die.
- Remove the Steel Ring from the Die.
- Remove all four Die Blades
- Insert four new Die Blades into the Die.
NOTE: When inserting the Die Blades, make sure the cutting edges of the Die Blades face inward and that the number on each Die Blade is at the top and in sequence.
- Once the Die Blades are properly inserted, replace the Steel Ring and four Screws.

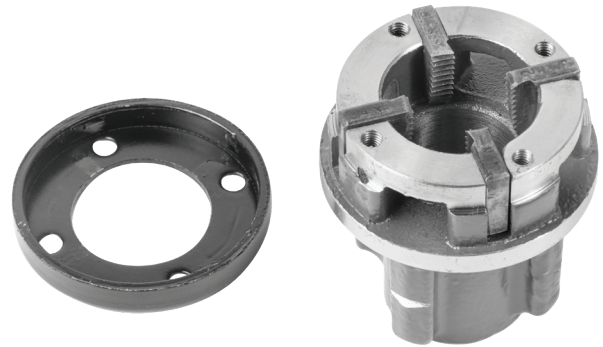

Figure D

7.3 Troubleshooting

PROBLEM	POSSIBLE CAUSES	LIKELY SOLUTIONS
Tool will not start.	<ol style="list-style-type: none"> 1. Cord not connected. 2. No power at outlet. 3. Tool's thermal reset breaker tripped (if equipped). 4. Internal damage or wear. (Carbon brushes or Trigger, for example.) 	<ol style="list-style-type: none"> 1. Check that cord is plugged in. 2. Check power at outlet. If outlet is unpowered, turn off tool and check circuit breaker. If breaker is tripped, make sure circuit is right capacity for tool and circuit has no other loads. 3. Turn off tool and allow to cool. Press reset button on tool. 4. Have technician service tool.
Tool operates slowly.	<ol style="list-style-type: none"> 1. Forcing tool to work too fast. 2. Extension cord too long or cord diameter too small. 	<ol style="list-style-type: none"> 1. Allow tool to work at its own rate. 2. Eliminate use of extension cord. If an extension cord is needed, use one with the proper diameter for its length and load. See Extension Cords section.
Performance decreases over time.	Carbon brushes worn or damaged.	Replace motor brushes. See "REPLACING BRUSHES IN MOTOR" in the Maintenance and Servicing section.
Excessive noise or rattling.	Internal damage or wear. (Carbon brushes or bearings, for example.)	Have technician service tool.
Overheating.	<ol style="list-style-type: none"> 1. Forcing tool to work too fast. 2. Blocked motor housing vents. 3. Motor being strained by long or small diameter extension cord. 	<ol style="list-style-type: none"> 1. Allow tool to work at its own rate. 2. Wear ANSI-approved safety goggles and NIOSH-approved dust mask/respirator while blowing dust out of motor using compressed air. 3. Eliminate use of extension cord. If an extension cord is needed, use one with the proper diameter for its length and load. See Extension Cords section.
Pipe doesn't fit Die.	<ol style="list-style-type: none"> 1. Die is inappropriate to pipe size. 2. Pipe inserted from wrong side. 3. Pipe not chamfered. 	<ol style="list-style-type: none"> 1. Choose a Die appropriate to the pipe. 2. Insert pipe from correct side. See Workpiece and Work Area Set Up. 3. Make sure pipe end-to-be-threaded is chamfered.
Pipe spins.	Clamp is upside-down for the rotation direction.	Move Clamp Bar to other side of Clamp. Turn Clamp upside down and reclamp it to pipe. See Workpiece and Work Area Set Up.
Dies break.	<ol style="list-style-type: none"> 1. Die Blades insufficiently lubricated. 2. Die Blades installed in wrong order or backwards. 	<ol style="list-style-type: none"> 1. Lubricate Die Blades sufficiently. See General Operating Instructions section. 2. Ensure cutting edges of Blades face inward and the number on each Die Blade is at the top and in sequence. See Replacing Die Blades section.



**Follow all safety precautions whenever diagnosing or servicing the tool.
Disconnect power supply before service.**

8.0 WARRANTY INFORMATION

LIMITED 1 YEAR WARRANTY

GARDNER BENDER LIMITED WARRANTY: Gardner Bender warrants its product against defects in workmanship and materials for 1 year from date of delivery to user. Chain is not warranted. Warranty does not cover ordinary wear and tear, abuse, misuse, overloading, altered products or use of improper fluid.

LIMITED: Limited means that GB warrants to the original purchasers of products from GB authorized distributors at the time of shipment such products shall be free of defects in material and workmanship while the tool is used under normal working conditions. Standard wear and tear, dulling over time, overloading, misuse, and acts of God are not covered under warranty. This warranty does not cover batteries, fuses, or test leads.

When a warranty claim arises, the purchaser must contact GB. If the defect comes under the terms of this limited warranty,

GB will arrange, at its sole discretion, one of the following options:

- The product will be repaired at an authorized GB Service Center
- Product will be replaced

The purchaser is solely responsible for determining the suitability of GB for the purchaser's use or resale, or for incorporating them into articles or using them in the purchaser's applications. The distributor is authorized to extend the foregoing limited warranty to its original purchasers in connection with the sales of GB products, provided that such products shall not have been altered by the distributor. The distributor shall be fully responsible for any warranties the distributor makes to its purchasers which are broader or more extensive than GB limited warranty.

See more at: <https://www.gardnerbender.com/en/Resources/Warranty-Information>



Warehouse-Lighting.com
2750 South 163rd St
New Berlin, WI 53151

Warehouse-Lighting.com
Phone: 888-454-4480
info@warehouse-lighting.com