

PRO-72T | VERSATILE DRILLING & TAPPING MACHINE

The PRO-72T drilling machine is suitable for hole cutting and tapping applications.

Powerful variable speed motor enables milling capacity up to 70 mm (2-3/4") and drilling capacity up to 25 mm (1").

Machine's forward & reverse work modes allow thread cutting up to M20 with Promotech's new tapping system.

Two speed gearbox with continuous speed adjustment allows to set the optimal speed depending on diameter, steel grade or tool type.













Intelligent speed control system maintains constant motor speed regardless of changing loads.

Innovative 360-degree LED indicator facilitates proper machine operation and increases work safety.

Features and benefits:

- powerful motor with heavy duty 2-speed gearbox
- intelligent speed control system maintains stable speed regardless of load changes
- tapping of through and blind holes
- milling with TCT or HSS cutters or drilling
- electronic clutch
- both overload and overheat protection
- rigid design extends tool life
- tilt sensor stops the motor if machine breaks away
- 360-degree visual monitoring system indicates current condition of the drill and gives safety and diagnostic information e.g. worn brushes
- innovative smart magnet with reduced weight
- intuitive control panel at top of the drill
- large coolant container



												
Core drill max 70 mm (2-3/4")	Twist drill max 25 mm (1")	Spindle MT3	Depth of cut 75 mm (3")	Stroke 190 mm (7-1/2")	Speed 120-190 rpm 290-450 rpm	Power 1600 W	Weight 18 kg (40 lbs)	Thread cutting M20 (7/8")	Worn brushes indicator	Thermal /overheat protection	Overload protection	Magnet detachment safeguard



Tapping through holes up to M20



Tapping blind holes up to M20



Counterclockwise (CCW) rotation
User-friendly control of tapping tool retract

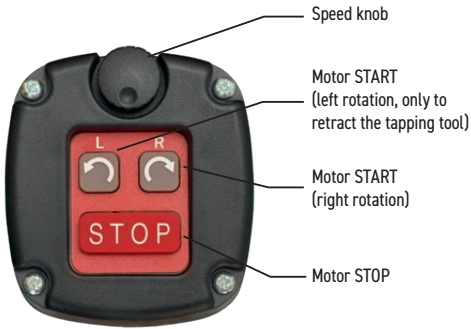

Intuitive control panel at top of the drill



Milling capacity up to 70 mm (2-3/4")
• Max depth up to 75 mm (3")



Drilling capacity up to 25 mm (1")
• Max stroke up to 190 mm (7-1/2")

360-degree Visual Monitoring System - VMS

	CONDITION OF THE DRILL		Ready to Operate (Solid Green)
			Normal Operation (Solid White)
			Motor Overheat (Solid Red)
			Emergency Stop/Overload Condition (Solid Blue)
			Emergency Stop/Low Adhesion (Solid Violet)
	SAFETY INFORMATION		Inadequate Adhesion (Flashing Green)
			Near Overload (Flashing Blue)
	DIAGNOSTIC INFORMATION		Emergency Stop/Voltage Drop (Red Flashes to Blue)
			Emergency Stop/Worn Brushes (Red Flashes to Green)



Promotech introduces quick change tapping system including:



- TC - Tapping chucks with securing nut
- TA - Tapping Adapters for through holes
- TASC - Tapping Adapters Safety Clutch for blind holes
- RA - Reduction Adapters

PRO-72T - Available tapping configurations

Tapping tool	Tapping chucks	
	MT3-19	MT3-31
M8	TA-1 or TASC-1	TA-1 or TASC-1 along with optional RA 2/1
M10		
M12		
M8	TA-2 or TASC-2	
M10		
M12		
M14		
M16		
M18		
M20		
Standard tapping configuration		Optional tapping configuration

Promotech quick change tapping system accessories suitable for PRO-72T drilling machine:



Tapping chuck equipped with securing nut protects tapping tool against pull out

TC – Tapping chucks with securing nuts

Product Code	Type	Description
OPR-0584-11-00-00-1	MT3-19	Tapping chuck MT3 x 19 mm
OPR-0584-08-00-00-1	MT3-31	Tapping chuck MT3 x 31 mm

TA – Tapping Adapters

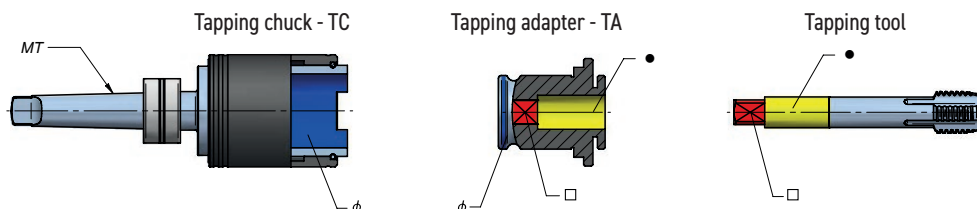

Product Code	Type	Description	∅ [mm]	Tap size	● [mm]	□ [mm]
WKL-000069	TA-1	Tapping Adapter 19 mm x M8	19	M8	8	6,2
WKL-000070	TA-1	Tapping Adapter 19 mm x M10	19	M10	10	8
WKL-000071	TA-1	Tapping Adapter 19 mm x M12	19	M12	9	7
WKL-000072	TA-2	Tapping Adapter 31 mm x M8	31	M8	8	6,2
WKL-000073	TA-2	Tapping Adapter 31 mm x M10	31	M10	10	8
WKL-000074	TA-2	Tapping Adapter 31 mm x M12	31	M12	9	7
WKL-000075	TA-2	Tapping Adapter 31 mm x M14	31	M14	11	9
WKL-000076	TA-2	Tapping Adapter 31 mm x M16	31	M16	12	9
WKL-000077	TA-2	Tapping Adapter 31 mm x M18	31	M18	14	11
WKL-000078	TA-2	Tapping Adapter 31 mm x M20	31	M20	16	12

TASC – Tapping Adapters Safety Clutch

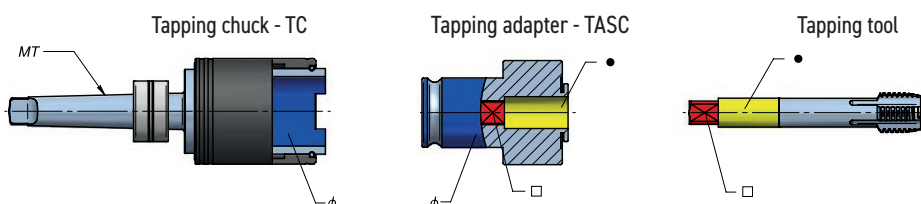

Product Code	Type	Description	∅ [mm]	Tap size	● [mm]	□ [mm]
WKL-000095	TASC-1	Tapping Adapter with Safety Clutch 19 mm x M8	19	M8	8	6,2
WKL-000098	TASC-1	Tapping Adapter with Safety Clutch 19 mm x M10	19	M10	10	8
WKL-000099	TASC-1	Tapping Adapter with Safety Clutch 19 mm x M12	19	M12	9	7
WKL-000100	TASC-2	Tapping Adapter with Safety Clutch 31 mm x M8	31	M8	8	6,2
WKL-000101	TASC-2	Tapping Adapter with Safety Clutch 31 mm x M10	31	M10	10	8
WKL-000102	TASC-2	Tapping Adapter with Safety Clutch 31 mm x M12	31	M12	9	7
WKL-000103	TASC-2	Tapping Adapter with Safety Clutch 31 mm x M14	31	M14	11	9
WKL-000104	TASC-2	Tapping Adapter with Safety Clutch 31 mm x M16	31	M16	12	9
WKL-000105	TASC-2	Tapping Adapter with Safety Clutch 31 mm x M18	31	M18	14	11
WKL-000106	TASC-2	Tapping Adapter with Safety Clutch 31 mm x M20	31	M20	16	12

RA – Reduction Adapters

Product Code	Type	Description
RDC-000008	RA 2/1	Reduction Adapter 2/1 (31 mm / 19 mm)

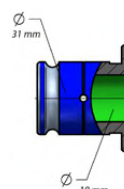

PRO-72T TECHNICAL SPECIFICATION	
Motor Speeds (under load)	120-190 rpm (gear I) 290-450 rpm (gear II)
Power	1600 W
Weight	18 kg (40 lbs)
Max milling capacity	70 mm (2-3/4")*
Max drilling capacity	25 mm (1")
Max Tap size	M20 (7/8")
Stroke	190 mm (7-1/2")
Max depth of cut	75 mm (3")
Voltage	1- 220-240 V, 50-60 Hz 1- 110-120 V, 50-60 Hz
Overload protection	yes
Overheat protection	yes
Continuous Speed Adjustment	yes
ESSS (Electronic Speed Stabilization System)	yes
Semi-automatic gib adjustment	yes
MFSC (Magnetic Field Shape Control)	yes
ESB - Energy Saving Base	yes
Magnet detachment safeguard	yes
Magnetic clamping force (surface with the thickness of 25 mm and roughness Ra = 1.25)	1122 kgf (11 000 N)
Magnet Base Dimensions	92 mm x 180 mm x 54 mm 3-5/8" x 7" x 2-1/8"
Min. Workpiece Thickness	8 mm (5/16)
Spindle	MT3
Tool holder	19 mm (3/4") Weldon
Product Code 220-240 V, 50-60 Hz	WRT-0686-10-20-00-0
Product Code 110-120 V, 50-60 Hz	WRT-0686-10-10-00-0

* If more than 60 mm (2-3/8"), use an MT3 arbor with 32 mm Weldon tool holder (UCW-0686-08-00-00-0)

Dimensions:

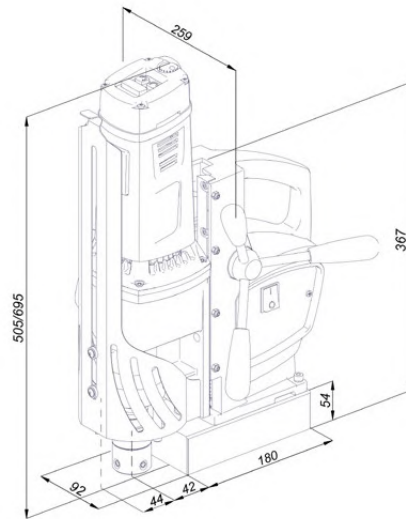

Standard shipping set:

- Drilling machine
- Plastic box
- Handle (3 pcs)
- MT3 arbor with 19 mm (3/4") Weldon tool holder
- Safety strap
- Cooling system
- Protective spring for cooling hose
- MT2 drift
- 5 mm hex wrench with a handle
- 4 mm hex wrench
- 2.5 mm hex wrench
- 8 mm combination wrench
- Operator's Manual

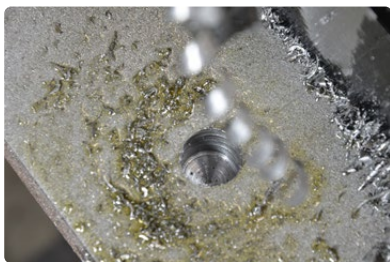

More optional accessories:



Arbor MT3 x 32 mm Weldon for drilling diameter over 60 mm (2.3") up to 50 mm (2") depth
product code: UCW-0686-08-00-00-0



Pipe attachment DMP 251 for pipes with diameters of 80-250 mm (3-10")
product code: PDS-0110-03-00-01-0



Pressure cooling system capacity of 2 liters
product code: UKL-0440-16-00-00-0



Pipe attachment DMP 501 for pipes with diameters of 150-500 mm (6-20")
product code: PDS-0111-03-00-01-0



All information is subject to change without notice. 20.07



PROMOTECH Sp. z o.o.
ul. Elewatorska 23/1, 15-620 BIAŁYSTOK, POLAND
tel. (+48 85) 678 34 05, fax (+48 85) 662 78 77
marketing@promotech.eu www.promotech.eu

Your local dealer:

