

## ■ OSC-8 | PENDULUM WEAVE WELDER

The OSC 8 pendulum oscillator is designed to oscillate MIG/MAG torches with the diameter of 16–22 mm (5/8–7/8”).

The oscillator is installed onto a 22 mm (7/8”) diameter rod and connected to a welding device.

It can be controlled manually or by using an external START-STOP switch.

Using an optional freestanding support allows welding of rotating pipes or moving plates. An optional power supply allows connecting the oscillator to a 230 V or 115V power source.

OSC-8 is suitable for MIG/MAG automate processes in heavy fabrication industries such as: pipeline and bridge construction, shipbuilding and tank welding.

### ■ Features & Benefits:

- lightweight and compact design
- two control modes: manual and external start
- four adjustable parameters (oscillation width, oscillation speed, oscillation dwell time on ends)
- simple control panel (four knobs)
- can work as stand-alone device or be a part of more advanced welding system
- optimal solution for various welding applications
- real improvement of the welding process
- uniform and high quality welding
- supply voltage 14-24 V (direct connection to the welding tractor or an external automation system)
- optional power supply 115 VAC or 230 VAC



OSC-8 can work either as stand-alone Pendulum Weave Welder or along with freestanding support or along with welding tractors.





OSC-8 along with Freestanding Support

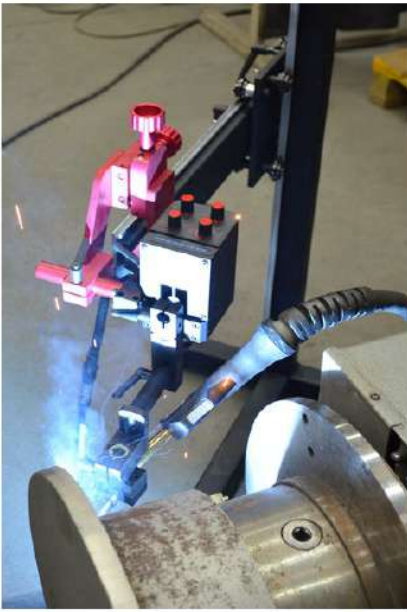

OSC-8 along with Rail Bull 2 tractor

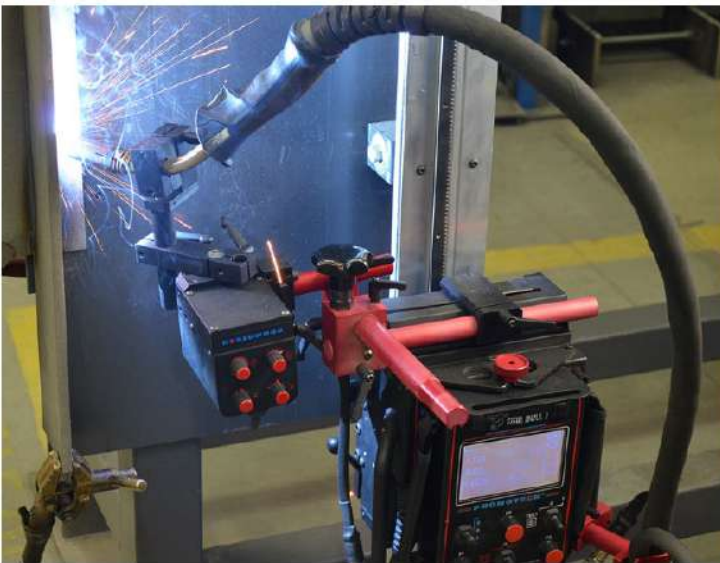

OSC-8 along with Rail Tug tractor

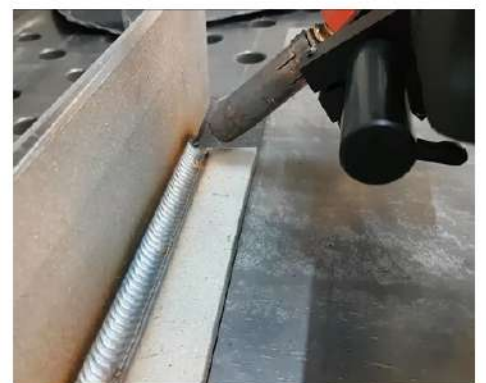

Depending on welding system configuration in use the oscillator can work in either manual or external start mode and be connected to:

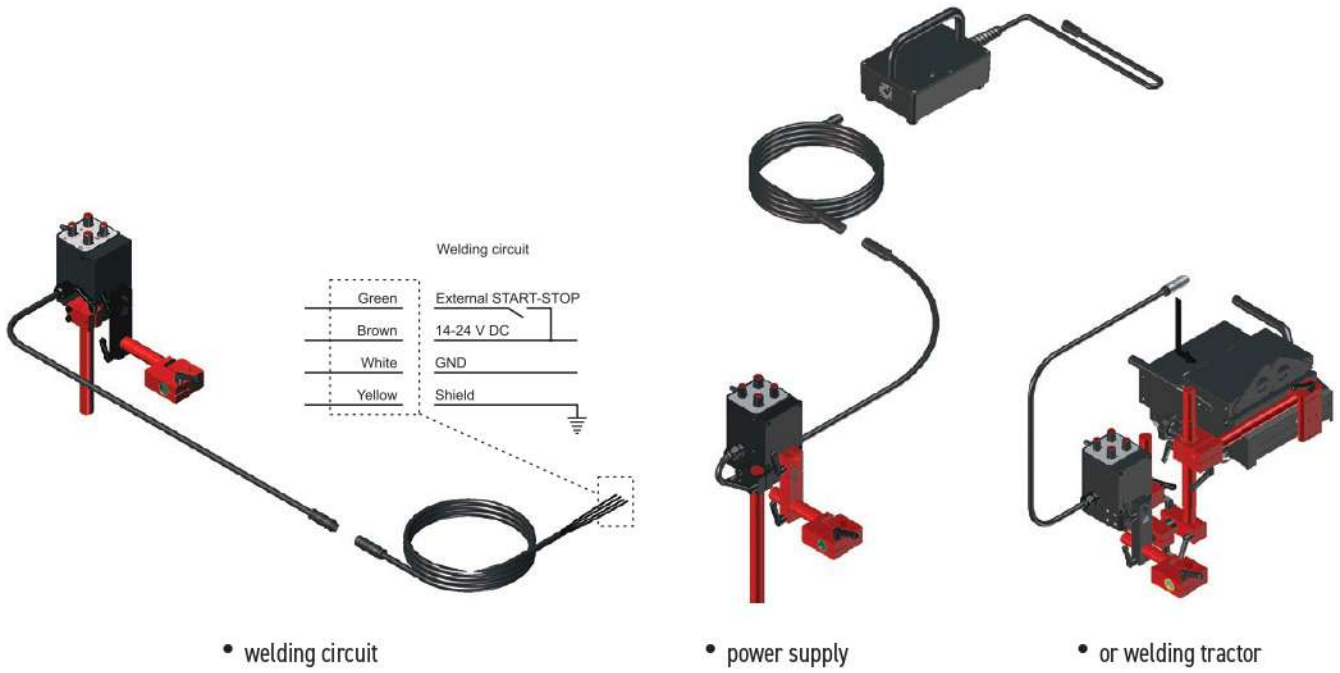

• welding circuit

• power supply

• or welding tractor

OSC-8 TECHNICAL SPECIFICATION	
Voltage	14-24 V DC
Power	50 W
Torch type	MIG/MAG
Torch diameter	16-22 mm (5/8-7/8")
Oscillation type	Pendulum
Oscillation width at r=150 mm (6")	1-30 mm (1-100%) 1/32-1-3/16" (1-100%)
Oscillation speed at oscillation width of 10 mm (3/8") and zero dwell time on ends	12-115 cycles/min (1-100%)
Oscillation dwell time on ends	0-3 s
Maximum torque	8 N·m (5.7 lb·ft)
Required ambient temperature	0-50°C (32-122°F)
Weight	2 kg (4 lbs)
Product code:	OSC-0497-10-00-00-0

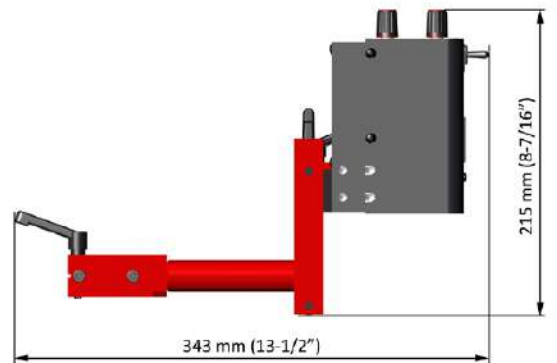
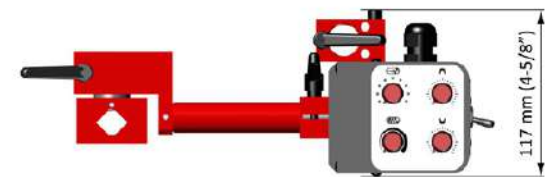

Parameter	Value	Description
	0-100%	Oscillation width.
	0-100%	Oscillation speed.
	0-3 s	Oscillation dwell time in the top position.
	0-3 s	Oscillation dwell time in the bottom position.

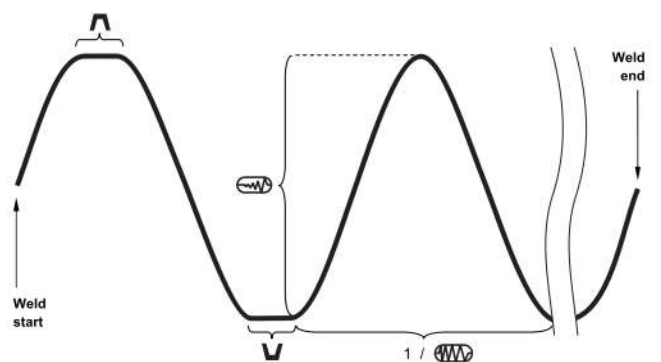



## Optional equipment:

### Power Supply (to be chosen from available voltage versions)

- Product codes:

- ZSL-0497-16-00-00-0 (230 V CEE)
- ZSL-0497-16-00-01-0 (115 V USA)
- ZSL-0497-16-00-02-0 (230 V AU)
- ZSL-0497-16-00-03-0 (230 V UK, type G)
- ZSL-0497-16-00-04-0 (230 V IN, type D)



### Freestanding Support:

- Holds the oscillator to allow oscillation welding of rotating pipes or moving plates
- Product code: STJ-0629-10-00-00

Torch type	MIG/MAG
Torch handle diameter	16-22 mm (5/8-7/8")
Arm horizontal stroke	560 mm (22")
Arm vertical stroke	640 mm (25")
Weight	15.3 kg (34 lbs)



### Rail Bull 2 accessories:



Rod 203 mm  
KLM-0236-00-16-00-0



Clamping block  
KST-0525-11-00-00-0

### Standard shipping set:

- Oscillator - 1 unit
- 2 m (6.5 ft) power cord - 1 unit
- Low rod torch holder with clip - 1 unit
- Oscillator arm - 1 unit
- Clamping block - 1 unit
- M6x40 screw - 2 units
- 80 mm (3") rod - 1 unit
- 5 mm hex wrench - 1 unit
- Operator's Manual - 1 unit



More information at [www.promotech.eu](http://www.promotech.eu)



PROMOTECH Sp. z o.o.  
ul. Elewatorska 23/1, 15-620 BIAŁYSTOK, POLAND  
tel. (+48 85) 678 34 05, fax (+48 85) 662 78 77  
marketing@promotech.eu www.promotech.eu

Your local dealer:

